

Cable Eye for C-Rail, Steel, 40 x 75 mm

Data Solutions

CATALOG NUMBER

20118-554

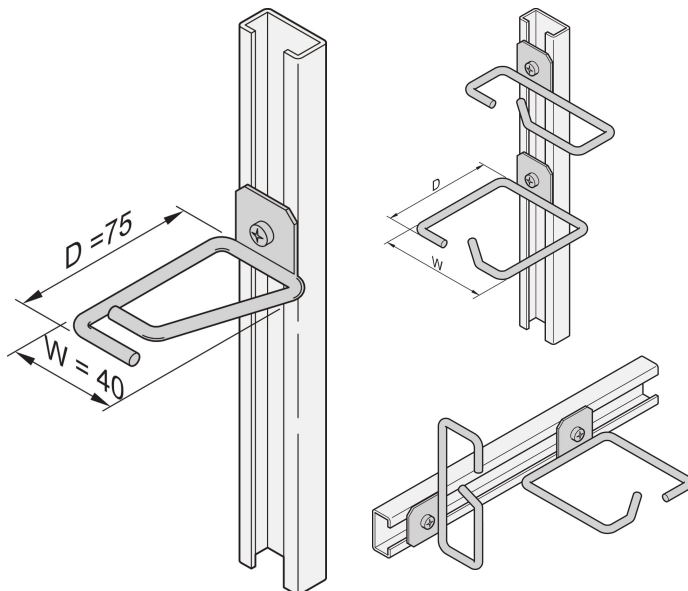

Cable eyes can be attached to slide rails, cable panels, etc.

CERTIFICATIONS



FEATURES

Cable eye for C-profile

PRODUCT ATTRIBUTES

Material: Steel

Package Quantity: 4

Finish: Zinc Plated

Product Family: Labrack

Product Type: Cable Eye

Net Weight: 0.195kg

ADDITIONAL PRODUCT DETAILS

Please order assembly kit separately.

WARNING

nVent products shall be installed and used only as indicated in nVent's product instruction sheets and training materials. Instruction sheets are available at www.nvent.com and from your nVent customer service representative. Improper installation, misuse, misapplication or other failure to completely follow nVent's instructions and warnings may cause product malfunction, property damage, serious bodily injury and death and/or void your warranty.



Our powerful portfolio of brands:

CADDY ERICO HOFFMAN ILSCO SCHROFF TRACHTE