

Busbar With FASTON Connections, 4 Pole, E-Cu tin-Plated

Data Solutions

CATALOG NUMBER

20100-017

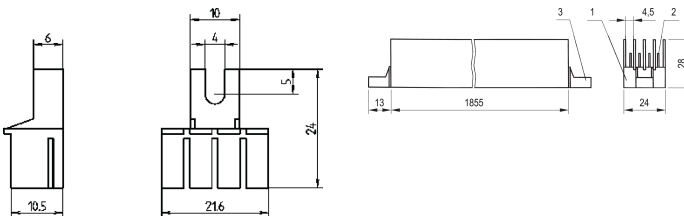
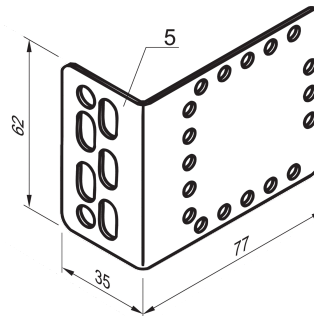
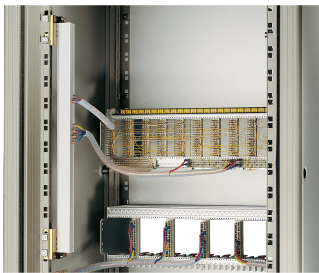

Schroff busbar is a metallic strip or bar, typically housed inside switchgear, panel boards, and busway enclosures for local high current power distribution.

CERTIFICATIONS



FEATURES

Connections FASTON 6.3 x 0.8 mm

Can be sawn off to required length

Vertical current distribution in cabinet

PRODUCT ATTRIBUTES

Material: Copper

Finish: Tin Plated

Number of Poles: 4

Package Quantity: 1

Product Type: Busbar

Net Weight: 1.3kg

WARNING

nVent products shall be installed and used only as indicated in nVent's product instruction sheets and training materials. Instruction sheets are available at www.nvent.com and from your nVent customer service representative. Improper installation, misuse, misapplication or other failure to completely follow nVent's instructions and warnings may cause product malfunction, property damage, serious bodily injury and death and/or void your warranty.



Our powerful portfolio of brands:

CADDY ERICO HOFFMAN ILSCO SCHROFF TRACHTE