

# nVent CADDY Macrofix Plus LF Low-Friction, 125 mm OD, 110 mm Plastic Pipe

## CATALOG NUMBER

**MPL125**



## FEATURES

Includes easy closing mechanism

Age resistant lining designed specifically for plastic pipe applications

Low-friction properties allow for expansion, contraction and easy sliding of pipe

Conforms with Manufacturers Standardization Society (MSS) SP-58 (Type 12)

Category II noise reduction according to DIN EN ISO 3822-1

Compliant for sound insulation design according to DIN 4109

## PRODUCT ATTRIBUTES

Article Number: 595046

Material: Steel;EPDM-SBR Rubber

Finish: Electrogalvanized

Color: Green

Temperature: -50 to 110 °C

Outer Diameter (OD): 125 mm

Plastic Pipe Size: 110mm

Rod Size (RS): M8;M10

Width (W): 30 mm

Thickness (T): 2.5 mm

Static Load: 2000N

## ADDITIONAL PRODUCT DETAILS

---

Lining is EPDM rubber.

## DIAGRAMS

---

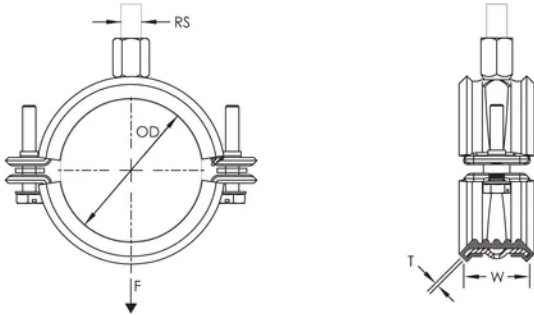

## WARNING

---

nVent products shall be installed and used only as indicated in nVent's product instruction sheets and training materials. Instruction sheets are available at [www.nvent.com](http://www.nvent.com) and from your nVent customer service representative. Improper installation, misuse, misapplication or other failure to completely follow nVent's instructions and warnings may cause product malfunction, property damage, serious bodily injury and death and/or void your warranty.

### North America

+1.800.753.9221  
Option 1 – Customer Care  
Option 2 – Technical  
Support

### Europe

Netherlands:  
+31 800-0200135  
France:  
+33 800 901 793

### Europe

Germany:  
800 1890272  
Other Countries:  
+31 13 5835404

### APAC

Shanghai:  
+ 86 21 2412 1618/19  
Sydney:  
+61 2 9751 8500



Our powerful portfolio of brands:

**CADDY ERICO HOFFMAN ILSCO SCHROFF TRACHTE**

