

**CONNECT AND PROTECT**

# nVent LENTON Quick Wedge

  
nvent

**LENTON**



The nVent LENTON Quick Wedge rebar splice is a mechanical lap splice designed for easy installation. It complements the extensive line of mechanical rebar splicing systems manufactured by nVent.

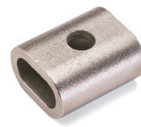

**Quick Wedge mechanical lap splice is one of the simplest, most efficient connections available.**



**The Quick Wedge system is easy to use – only minimal training is required.**

## THE SIMPLE AND QUICK ALTERNATIVE FOR JOINING SMALL DIAMETER REINFORCING BARS.

The Quick Wedge splice consists of an oval shaped steel sleeve and a wedge pin. The sleeve is positioned around two overlapping steel bars. The wedge pin is inserted into a handheld hydraulic pin-driver and positioned on the sleeve. The pin is then driven through the pre-drilled hole in the sleeve and between the bars to complete the connection. A pin is driven in seconds. It's that simple!

Only one pin-driver is required to install splices on bar sizes #4, #5 and #6 (12, 16 and 20 mm). Specially designed adapters are used to accommodate this range. A standard 10,000 PSI (700 Bar) hydraulic "dump pump" powers the pin-driver. The pump is available in both 110\* and 220 volts.

The Quick Wedge system is so simple to use that only minimal training is required. Connections can be made outdoors in virtually any weather conditions and the finished connection can be quickly inspected visually. Add to that a low cost, and you can easily see why the Quick Wedge mechanical lap splice is one of the simplest, most efficient connections available.

The Quick Wedge system eliminates the need to custom cut and fit rebar to precise measurements, as in butt splicing. Instead, the bars can be cut to approximate size that will span between the rebar being joined. The final connection can be made with the bars extending beyond the coupler ends. This Quick Wedge advantage will save you time in road repair and retrofit applications.



A short bar end in a minimum clearance application? No problem with Quick Wedge. To achieve maximum connection strength, all you need to do is make the end of each bar flush with the ends of the splice sleeve. In fact, testing has shown Quick Wedge connections with reinforcing steel according to BS4449 and AS/NZS 4671, exceed the characteristic yield strength of the reinforcing steel. On ASTM® A615 grade 60 reinforcing steel, the ACI® 318 Type 1 requirements are exceeded, with a splice strength of minimum 125% of specified yield. The system can also develop 120% of specified yield or 110% of actual yield for CSA® A23.3-1994 (using G30.18-1992 grade 400 MPA reinforcing bar.)

\*110V standard in U.S.

*Quick Wedge Protruding bars from the precast wall are joined using an oval shape coupler. The bars are overlapped and assembled using a hydraulic hand tool. Cast-in-place concrete is poured after the connections are completed.*

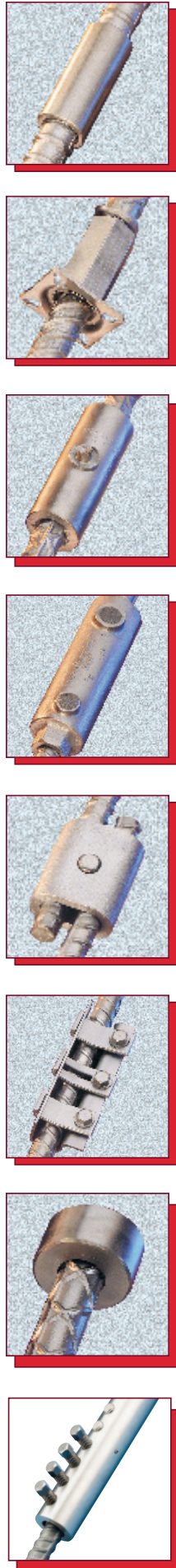

## FEATURES AND BENEFITS

- Quick installations result in accelerated job scheduling
- Cost effective with one-cycle tool operation
- Minimal exposed bar-ends result in reduced concrete chipping (as short as 2-9/16" (65 mm))
- Only one-man "crew" needed to operate lightweight portable hydraulic pin-driver
- No special bar-end treatment gives the ability to connect virtually any bar condition
- Eliminates custom fit rebar with "lapped bar" capability
- Easy field adjustability provides greater job site versatility
- Reduces unforeseen delays because Quick Wedge can be installed in virtually any weather
- Minimal detailing helps eliminate incorrect interpretation and communication errors
- Splice offers quick visual inspection

## APPLICATIONS

**Road Repair** – Ideal for replacing bars removed when pavement sections require maintenance. Speed, minimum existing exposed bar requirements, reduced concrete chipping, and adjustability due to the "lapped" feature make this a natural.



**Bridge Repair** – Provides a fast and effective means for connecting bars required in bridge deck upgrades, especially when congestion makes the job even tougher! You realize the same advantages found in "road repair" above.

**Precast** – May be used to join rebar extending from concrete walls or slabs before a closure pour.

**Building Extensions** – Because the system can be installed on a short bar and in limited space, this is a great way to connect existing bar to new in-building expansions.



**Spiral Reinforcement** – Joins coils quickly and easily. Positioning and curvature of spiral is easily accommodated in the field.

**Stirrups and Ties** – Affords an efficient means for closing column stirrups – reducing detailing, fabrication, and congestion.

**Pile Extensions** – Quick Wedge splices are an efficient way to extend rebar from piles that have been driven below desired elevation.

**Epoxy Coated Rebar** – Epoxy coated rebar can be easily joined. Contact nVent for details.

Quick Wedge provides a fast, low-cost method for joining small diameter rebar. For assistance in selecting the best rebar splicing system for your application, visit us at [nVent.com/LENTON](http://nVent.com/LENTON).

# INSTALLATION DETAILS

## Quick Wedge – as easy as...

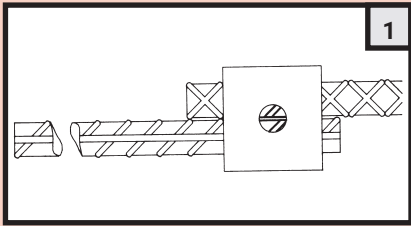

Position the sleeve onto the rebar; bar ends must be at least flush with sleeve ends.

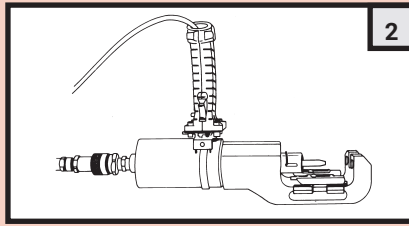

Place the pin in the driver.

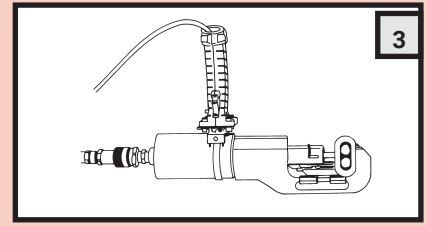

Position the pin-driver on the coupler and drive the pin.

### Sleeve Dimensions

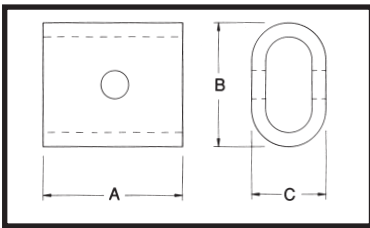

### Minimum Clearance Tool End

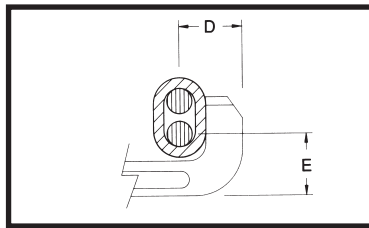

### Minimum Dowel Length

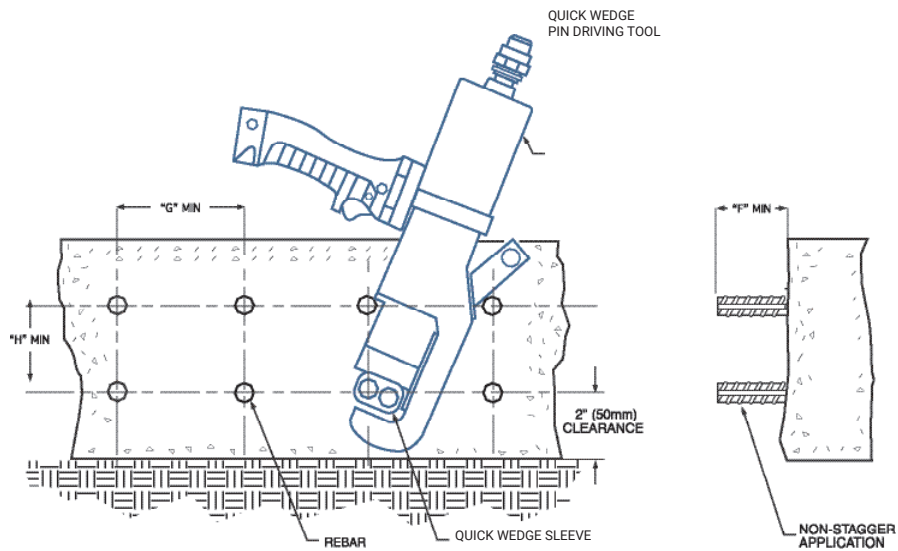
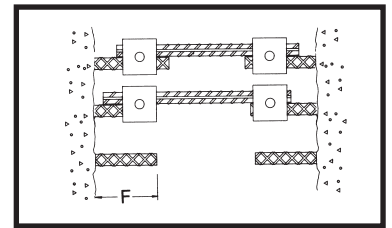

Rebar Size Designation						"A"	"B"	"C"	"D"	"E"	"F"	"G"	"H"	Weight									
in-lb	Metric	Canadian	Soft Metric	Part Number	Article Number	in	mm	in	mm	in	mm	in	mm	in	mm	lb	kg						
*-	12mm	10M	-	ML12MM	145700	1-7/8	48	1-5/8	41	1-1/16	27	1-5/8	41	2	51	2-9/16	65	5	127	2-1/2	64	0.42	0.19
4	12mm	-	13	ML4	-	1-7/8	48	1-11/16	43	1-1/16	27	1-5/8	41	1-15/16	49	2-9/16	65	5	127	2-1/2	64	0.44	0.20
*5	16mm	15M	16	ML5	145710	2-1/4	57	1-15/16	49	1-5/16	33	1-3/4	44	1-15/16	49	2-3/4	70	5	127	2-1/2	64	0.72	0.33
6	20mm	20M	19	ML6	-	2-3/4	70	2-3/8	60	1-9/16	40	1-15/16	49	1-7/8	48	3	76	5	127	3	76	1.34	0.61
*-	20mm	-	-	ML20MM	145720	2-3/4	70	2-3/8	60	1-9/16	40	1-15/16	49	1-7/8	48	3	76	5	127	3	76	1.34	0.61

\*Standard product in Europe and Australia.



[nVent.com/LENTON](http://nVent.com/LENTON)

**WARNING:** nVent products shall be installed and used only as indicated in nVent's product instruction sheets and training materials. Instruction sheets are available at [nVent.com/ERICO](http://nVent.com/ERICO) and from your nVent customer service representative. Improper installation, misuse, misapplication or other failure to completely follow nVent's instructions and warnings may cause product malfunction, property damage, serious bodily injury and/or death, and void your warranty.

©2018 nVent. All nVent marks and logos are owned or licensed by nVent Services GmbH or its affiliates. All other trademarks are the property of their respective owners. nVent reserves the right to change specifications without notice. Lenton-SB-CP7B-C690LT10WWEN-EN-1805