

# Cable Eye for C-Rail, Steel, 40 x 75 mm

## Data Solutions

### CATALOG NUMBER

---

**20118-554**

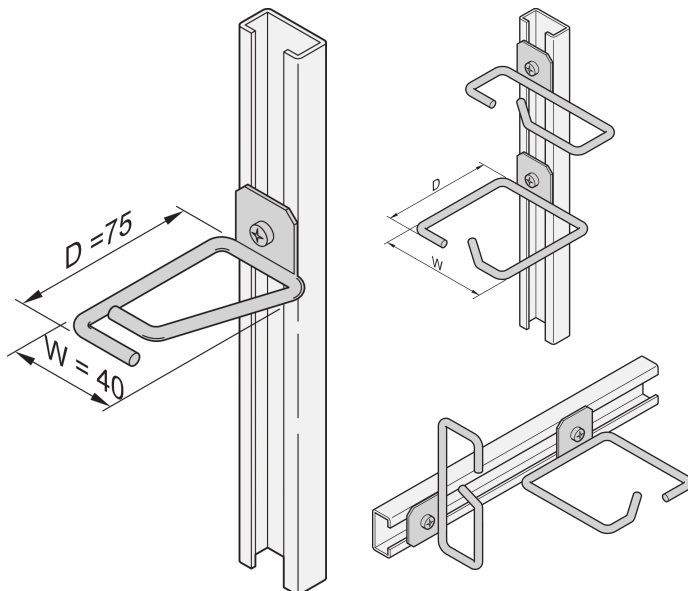

Cable eyes can be attached to slide rails, cable panels, etc.

### CERTIFICATIONS

---



### FEATURES

---

Cable eye for C-profile

### PRODUCT ATTRIBUTES

---

Material: Steel

Package Quantity: 4

Finish: Zinc Plated

Product Family: Labrack

Product Type: Cable Eye

Net Weight: 0.195kg

## ADDITIONAL PRODUCT DETAILS

---

Please order assembly kit separately.

## WARNING

---

nVent products shall be installed and used only as indicated in nVent's product instruction sheets and training materials. Instruction sheets are available at [www.nvent.com](http://www.nvent.com) and from your nVent customer service representative. Improper installation, misuse, misapplication or other failure to completely follow nVent's instructions and warnings may cause product malfunction, property damage, serious bodily injury and death and/or void your warranty.



Our powerful portfolio of brands:

**CADDY ERICO HOFFMAN ILSCO SCHROFF TRACHTE**