

# EuropacPRO 19" Subrack Kit for Backplane, Shielded, 3 U, 475 mm

## KATALOGNUMMER

24563-146

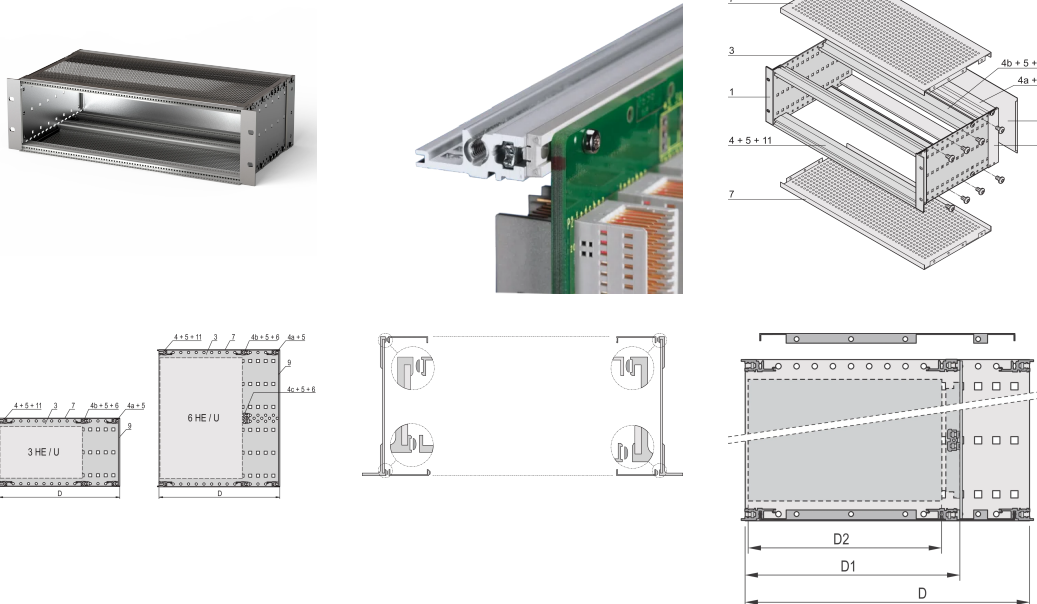

EMC Shielded subrack for backplane mounting, rear side covered by a rear panel.

## CERTIFICERINGER



## FUNKTIONER

Subrack with side panel type F ("flexible"), front 19" bracket included, depth-adjustable 19" bracket sold separately (not included in items delivered)

Supplied as space-saving flat-pack

Modifications such as cutouts, different finishes or dimensions available

EMC of approximately 40 dB at 1 GHz, 30 dB at 2 GHz, assuming that the front is covered with shielded front panels, testing in accordance with VG 95373 part 15

IP 20, in accordance with IEC 60529

Aluminum construction

Internal and external dimensions in accordance with: IEC 60297-3-100, -101, IEEE 1101.1

Rear horizontal rail for backplane mounting with insulation strip

Horizontal rail type "light"

## PRODUKTEGENSKABER

---

Rack Height: 3U

Dybde (D): 475mm

Pakke mængde: 1

For Mounting: Backplane

Board Depth: 160mm; 220mm; 280mm

Gasket Type: Textile EMC

Håndtag inkluderet: No

Mounting: Rack

Complies With: IEC 60297-3-103

EMC Shielding: Yes

Finish: Anodized; Passivated

Materiale: Aluminium

Product Type: Subrack/Chassis

Rack Width: 84HP

Static Load: 11kg

Net Weight: 3.45kg

## YDERLIGERE PRODUKTOPLYSNINGER

---

Individual configuration: broad range of variants in height, width and depth; guide rails for a wide variety of applications; interior options; accessories and mounting material.

## DIAGRAMS

---

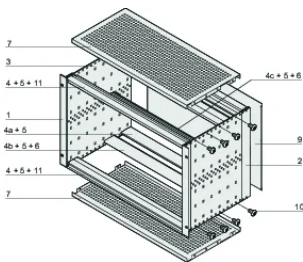

## ADVARSEL

---

nVent-produkter skal kun installeres og anvendes som angivet i nVents produktvejledninger og træningsmaterialer. Vejledninger er tilgængelige på [www.nvent.com](http://www.nvent.com) og hos din nVent kundeservicerepræsentant. Forkert installation, misbrug, fejlanvendelse eller anden unndladelse af fuldt ud at følge nVents instruktioner og advarsler kan medføre funktionsfejl, materielle skader, alvorlige personskader eller død og/eller ugyldiggøre din garanti.

### North America

All locations  
+1.763.422.2661  
Chat with us:  
[nvent.com/schroff](http://nvent.com/schroff)

### Europe

Straubenhardt, Germany  
+49.7082.794.0  
Betschdorf, France  
+33.3.88.90.64.90  
Warsaw, Poland  
+48.22.209.98.35  
Assago, Italy  
+39.02.932.7141  
Chat with us:  
[nvent.com/schroff](http://nvent.com/schroff)

### Asia

Shanghai, China  
+86.21.2412.6943  
Qingdao, China  
+86.532.8771.6101  
Singapore  
+65.6768.5800  
Shin-Yokohama, Japan  
+81.45.476.0271  
Chat with us:  
[nvent.com/schroff](http://nvent.com/schroff)

### Middle East & India

Dubai, United Arab  
Emirates  
+971.4.378.1700  
Bangalore, India  
+91.80.6715.2001  
Istanbul, Turkey  
+90.216.250.7374  
Chat with us:  
[nvent.com/schroff](http://nvent.com/schroff)



Vores kraftfulde portefølje af mærker:

**CADDY   ERICO   HOFFMAN   ILSCO   SCHROFF   TRACHTE**