

EMC Shielding Kit, Between Horizontal Rails, Stainless Steel, 40 HP

KATALOGNUMMER

24562-540

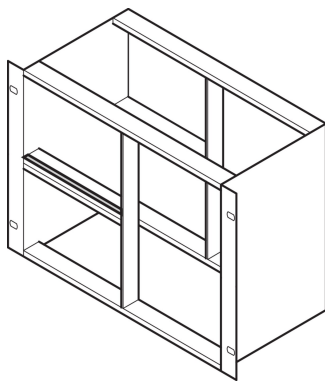

The contact strip makes contact between horizontal rails. If two horizontal rails are mounted one above the other, the seals plus a metal strip enable EMC shielding.

CERTIFICERINGER



FUNKTIONER

If two horizontal rails are mounted one above the other, the seals plus a metal strip enable EMC shielding

PRODUKTEGENSKABER

Rack Width: 40HP

Pakke mængde: 1

Length: 208mm

Materiale: Stainless Steel; Aluminium

Produktfamilie: EuropacPRO

Product Type: Shielding Kit

Works With: Subracks

Net Weight: 0.028kg

ADVARSEL

nVent-produkter skal kun installeres og anvendes som angivet i nVents produktvejledninger og træningsmaterialer. Vejledninger er tilgængelige på www.nvent.com og hos din nVent kundeservicerepræsentant. Forkert installation, misbrug, fejlanvendelse eller anden unkladelse af fuldt ud at følge nVents instruktioner og advarsler kan medføre funktionsfejl, materielle skader, alvorlige personskader eller død og/eller ugyldiggøre din garanti.

North America

All locations
+1.763.422.2661
Chat with us:
nvent.com/schroff

Europe

Straubenhardt, Germany
+49.7082.794.0
Betschdorf, France
+33.3.88.90.64.90
Warsaw, Poland
+48.22.209.98.35
Assago, Italy
+39.02.932.7141
Chat with us:
nvent.com/schroff

Asia

Shanghai, China
+86.21.2412.6943
Qingdao, China
+86.532.8771.6101
Singapore
+65.6768.5800
Shin-Yokohama, Japan
+81.45.476.0271
Chat with us:
nvent.com/schroff

Middle East & India

Dubai, United Arab Emirates
+971.4.378.1700
Bangalore, India
+91.80.6715.2001
Istanbul, Turkey
+90.216.250.7374
Chat with us:
nvent.com/schroff



Vores kraftfulde portefølje af mærker:

CADDY ERICO HOFFMAN ILSCO SCHROFF TRACHTE