

# 19" Pusher Fan, 2 U, Axial, 230 VAC, Board Depth 160 mm, 445 - 530 m<sup>3</sup>h

## KATALOGNUMMER

10713-534

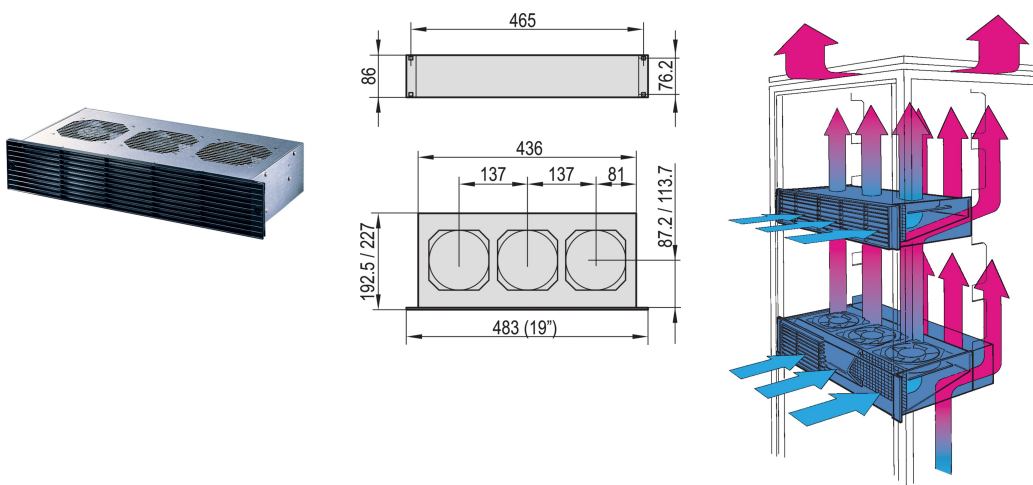

Fan tray with integrated pusher fan.

## CERTIFICERINGER



## FUNKTIONER

Contact protection in accordance with DIN EN ISO 13857

Integrated air deflector prevents heat buildup in the assemblies mounted below

Can be adapted to subracks

Optionally with additional rear fan, 2 U, for active cooling of assemblies beneath the pusher fan

## PRODUKTEGENSKABER

Product Type: Fan Unit

Indgangsspænding AC: 230V

Pakke mængde: 1

Finish: Aluminum-Zinc Plated

Materiale: Stål; Polypropylene

Net Weight: 4.09kg

## YDERLIGERE PRODUKTOPLYSNINGER

---

Please order mains cable separately.

## ADVARSEL

---

nVent-produkter skal kun installeres og anvendes som angivet i nVents produktvejledninger og træningsmaterialer. Vejledninger er tilgængelige på [www.nvent.com](http://www.nvent.com) og hos din nVent kundeservicerepræsentant. Forkert installation, misbrug, fejlanvendelse eller anden unndladelser af fuldt ud at følge nVents instruktioner og advarsler kan medføre funktionsfejl, materielle skader, alvorlige personskader eller død og/eller ugyldiggøre din garanti.

### North America

All locations  
+1.763.422.2661  
Chat with us:  
[nvent.com/schroff](http://nvent.com/schroff)

### Europe

Straubenhardt, Germany  
+49.7082.794.0  
Betschdorf, France  
+33.3.88.90.64.90  
Warsaw, Poland  
+48.22.209.98.35  
Assago, Italy  
+39.02.932.7141  
Chat with us:  
[nvent.com/schroff](http://nvent.com/schroff)

### Asia

Shanghai, China  
+86.21.2412.6943  
Qingdao, China  
+86.532.8771.6101  
Singapore  
+65.6768.5800  
Shin-Yokohama, Japan  
+81.45.476.0271  
Chat with us:  
[nvent.com/schroff](http://nvent.com/schroff)

### Middle East & India

Dubai, United Arab  
Emirates  
+971.4.378.1700  
Bangalore, India  
+91.80.6715.2001  
Istanbul, Turkey  
+90.216.250.7374  
Chat with us:  
[nvent.com/schroff](http://nvent.com/schroff)



Vores kraftfulde portefølje af mærker:

**CADDY ERICO HOFFMAN ILSCO SCHROFF TRACHTE**