

19" Pusher Fan, 2 U, Axial, 230 VAC, Board Depth 220 mm, 445 - 530 m³h

KATALOGNUMMER

10713-526

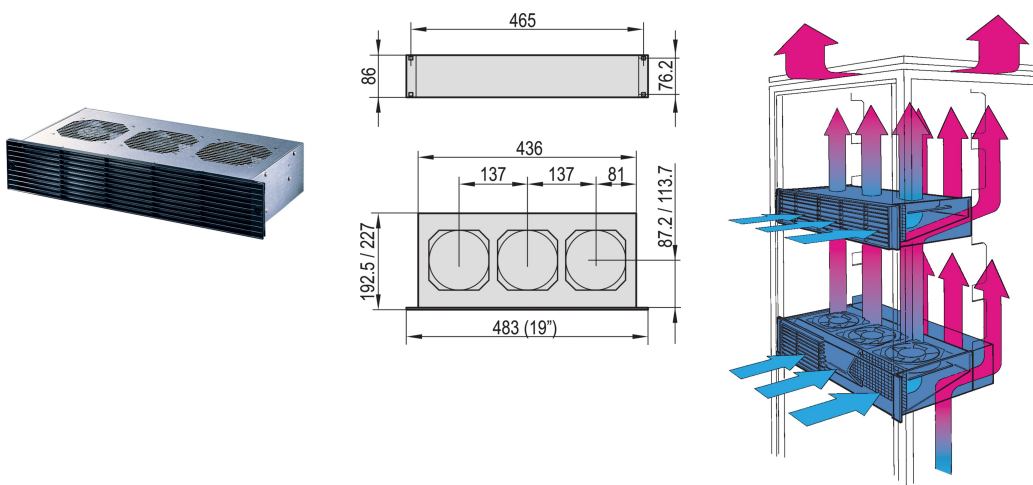

Fan tray with integrated pusher fan.

CERTIFICERINGER



FUNKTIONER

Contact protection in accordance with DIN EN ISO 13857

Integrated air deflector prevents heat buildup in the assemblies mounted below

Can be adapted to subracks

Optionally with additional rear fan, 2 U, for active cooling of assemblies beneath the pusher fan

PRODUKTEGENSKABER

Product Type: Fan Unit

Indgangsspænding AC: 230V

Pakke mængde: 1

Finish: Aluminum-Zinc Plated

Materiale: Stål; Polypropylene

Net Weight: 4.43kg

YDERLIGERE PRODUKTOPLYSNINGER

Please order mains cable separately.

ADVARSEL

nVent-produkter skal kun installeres og anvendes som angivet i nVents produktvejledninger og træningsmaterialer. Vejledninger er tilgængelige på www.nvent.com og hos din nVent kundeservicerepræsentant. Forkert installation, misbrug, fejlanvendelse eller anden unndladelser af fuldt ud at følge nVents instruktioner og advarsler kan medføre funktionsfejl, materielle skader, alvorlige personskader eller død og/eller ugyldiggøre din garanti.

North America

All locations
+1.763.422.2661
Chat with us:
nvent.com/schroff

Europe

Straubenhardt, Germany
+49.7082.794.0
Betschdorf, France
+33.3.88.90.64.90
Warsaw, Poland
+48.22.209.98.35
Assago, Italy
+39.02.932.7141
Chat with us:
nvent.com/schroff

Asia

Shanghai, China
+86.21.2412.6943
Qingdao, China
+86.532.8771.6101
Singapore
+65.6768.5800
Shin-Yokohama, Japan
+81.45.476.0271
Chat with us:
nvent.com/schroff

Middle East & India

Dubai, United Arab
Emirates
+971.4.378.1700
Bangalore, India
+91.80.6715.2001
Istanbul, Turkey
+90.216.250.7374
Chat with us:
nvent.com/schroff



Vores kraftfulde portefølje af mærker:

CADDY ERICO HOFFMAN ILSCO SCHROFF TRACHTE